



Translation of the Original Operating Instructions

perma
ECOSY 5

The Expert in Lubrications Solutions

perma

This operating manual is valid for the electronically controlled oil lubrication system perma ECOSY 5.

Electronically controlled oil lubrication system perma ECOSY 5

This oil lubrication equipment is a complete system. With consistent pressure, it reliably supplies exact amounts of oil to up to six lubrication points. Each lubrication point can be supplied with a different amount of oil. The amount of oil that each lubrication point requires can easily be set via the menu display.

EXCEPTION: When triggering an “additional discharge”, all outlets are supplied with the same amount of lubricant.

© 2002 - 2015 perma-tec GmbH & Co. KG

Without the specific approval of perma-tec GmbH & Co. KG, no part of this documentation may be copied or made available to third parties.

We have taken great care when compiling all details contained in this documentation. However, we cannot rule out incorrect or incomplete details.

We do not assume any judicial responsibility or liability for damages which may ensue as a result.

We reserve the right to make technical changes to the product without giving advance notice.

We will include any necessary changes in the next edition of this operating manual.

Product and brand names stated in this operating manual are the property of the relevant manufacturer and/or owner of the brand name and are protected accordingly. Brand and proprietor names are stated for technical information only. Hereby, we do not intend to infringe any rights and we neither recommend nor advise you against a product.

Compiled and printed: 13 / 11 / 2015

Contents

Validity of the Operating Manual and Information on this Publication	2
The Electronically Controlled Oil Lubrication System perma ECOSY 5	2
Table of contents	3
1 Various	5
1.1 About this Operating Manual	5
1.2 Versions and Scope of Delivery	6
1.3 The Oil Lubrication System perma ECOSY 5	7
1.4 Legal Requirements	8
2 Safety Instructions	9
2.1 Staff Responsible for Safety	9
2.2 General Safety Instructions	9
2.3 Safety Instructions for perma ECOSY 5	10
2.4 Safety When Handling Lubricants	11
2.5 Safety in Case of Fire	11
3 Technical Data	12
3.1 Product Characteristics	12
3.2 Operating Conditions	15
4 Storage	16
4.1 General Remarks on Storage	16
5 Mounting	17
5.1 Electrical Requirements	17
5.2 Required Tools (depending on mounting location)	17
5.3 Mounting the Lubrication System	17
5.4 Connection to Power Supply	18
6 Operation	19
6.1 Preparation	19
6.2 First Start and Operation	19
6.3 Check Prior to Operation	20
6.4 During Operation	20
7 Refilling the Reservoir	21
7.1 General Points to Consider	21
7.2 Refilling Procedure	21

8	perma ECOSY 5 Settings	22
8.1	Control Panel Settings (Edit-Mode).....	22
8.2	Function Indication	24
8.3	Setting of Parameters	26
8.3.1	Setting of Discharge Amount.....	26
8.3.2	Setting of Temperature Limit	28
8.4	System Configuration	30
8.4.1	The Operating Modes - Selecting the Operating Mode.....	30
8.4.2	Setting of Operating Mode	34
8.4.3	Setting of Temperature Unit (°C or °F)	36
8.4.4	Setting of Language (pre-set to German)	38
8.4.5	Adjusting the Contrast.....	40
8.4.6	PIN (Personal Identification Number).....	42
8.5	Carrying Out a Test Run.....	44
8.5.1	Test Run for a Single Outlet	44
8.5.2	Test Run for All Outlets.....	45
9	Discharge Amount From Pump to Distributor Dependent on Counter Pressure and Temperature	47
10	Connection of perma ECOSY 5	48
10.1	The Mains Supply (85 - 240 V AC) - Connection Via Plug-in Connector A.....	48
10.2	The Control Panel - Connection Via Plug-in Connector B.....	49
10.2.1	Connection Via Relays	50
10.2.2	Direct Connection to PLC.....	50
10.2.3	Connection of ECOSY Control sensor	51
11	Troubleshooting	52
12	Dismounting the Lubrication System	54
12.1	Preparation for Dismounting	54
12.2	Dismounting the ECOSY 5.....	55
13	Shipping	55
14	Disposal	56
15	Accessories for perma ECOSY 5	57
15.1	Accessories.....	57
15.2	Spare Parts	57
16	Maintenance and Service	58
	EC Declaration of Conformity	59

1 Various

1.1 About this Operating Manual

- This operating manual is intended for the safe operation of the automatic lubrication system perma ECOSY 5. It contains safety instructions which must be strictly adhered to.
- Everyone who works on or with the lubrication system must have access to this operating manual during their shift. They must pay attention to all relevant instructions and notices.
- The operating manual must always be kept complete and in easy to read condition.
- Please also refer to the data sheets of lubricants used in the system.

1.1.1 Terms Used

Lubrication System

In the following text, the system will either be called „lubrication system“ or by its brand name „perma ECOSY 5“.

1.1.2 Safety Instructions

All safety instructions in this operating manual are standardized according to ANSI Z535.4. The keywords are used in accordance with this standard.

WARNING



This sign is always printed BEFORE the work step. This sign indicates a hazardous situation which, if not avoided, could result in death or serious injuries!

CAUTION



This sign is always printed BEFORE the work step. This sign warns you of minor or moderate personal injury and possible damages to machines, equipment, devices or tools!

Note



This sign is used to address practices not related to personal injury. It gives you tips on doing certain tasks quicker and safer. This sign is always printed AFTER the work step

1.2 Versions and Scope of Delivery

- perma ECOSY 5, its attached parts and oil composition are individually put together according to customer requirements.
- The lubrication system is delivered with an oil-filled pump . The reservoir is empty. The oil must be ordered separately and will be delivered in a separate container.
- 2 plugs (4-pole and 8-pole)
- Upon delivery, make sure to check if the delivered goods correspond to your order. perma-tec GmbH & Co. KG will not accept liability for subsequent claims of any shortcomings.

Please immediately forward any claims:

- of noticeable transport damage directly to the forwarder.
- of noticeable faults, shortcomings or defects directly to your perma distributor.

1.3 The Oil Lubrication System perma ECOSY 5

1.3.1 Markings

- The perma ECOSY 5 lubrication system is clearly marked with a label on the pump.
- CE mark on the reservoir
- Manufacturer:
perma-tec GmbH & Co. KG
Hammelburger Straße 21
97717 Euerdorf
Germany

Phone: +49 (0) 97 04 609-0 E-mail: info@perma-tec.com
Telefax: +49 (0) 97 04 609-50 Homepage: www.perma-tec.com

1.3.2 Intended Usage

The perma ECOSY 5 lubrication system

- ... is intended for use on stationary machinery and equipment.
- ... supplies up to 6 connected lubrication points with oil, permanently, precisely and at a pressure build-up of max. 10 bar.
- ... can be used for all lubrication points of sliding and rolling bearings, drive and transport chains, sliding guideways, open gears and seals.
- ... is only to be used for the ordered purpose and purposes confirmed by perma-tec.
- ... is only to be used for operating conditions specified in this operating manual.
- ... is only to be used with settings and variations specified in this operating manual.

1.3.3 Inappropriate Use

Any other usage, setting and variation is considered to be inappropriate so that the manufacturer can no longer be held responsible.

CAUTION



DO NOT install this lubrication system in vehicles and ships, and/or on mobile equipment and/or equipment parts!

The lubrication system may not be used inappropriately, e.g.

- ... as a medicine dispenser
- ... as a food dispenser, or as an animal food dispenser
- ... with chemically aggressive substances (e.g. acids, solvents)
- ... with explosives (e.g. nitroglycerine)

1.4 Legal Requirements**1.4.1 Liability**

- The information, data and tips stated in this operating manual were up-to-date as of the printing date. No claims for already delivered lubrication systems can be made based on the information, pictures and descriptions.
- perma-tec GmbH & Co. KG can not be held liable for damages and malfunctions caused by:
 - ... violation and/or non-observance of the safety instructions
 - ... inappropriate usage
 - ... unauthorized alterations of the lubrication system
 - ... inappropriate operations on or with the lubrication system
 - ... incorrect operation and settings of the lubrication system
 - ... ignoring the operating manual

1.4.2 Warranty

- Warranty terms and conditions: see terms and conditions of sale and delivery appertaining to perma-tec GmbH & Co. KG.
- Lodge any warranty claims with your local supplier immediately after the defect or error has been identified.
- The warranty expires in all instances where no liability claims can be enforced.

2 Safety Instructions

2.1 Staff Responsible for Safety

2.1.1 Operator

The operator is every natural or legal entity who or which uses the lubrication system or on whose authority the lubrication system is used. For operation on and with the lubrication system, the operator and/or his safety officer must warrant:

- ... that for all tasks to be done the relevant laws, regulations, rules for prevention of accidents and safety instructions are observed.
- ... that only qualified personnel will work with and on the lubrication system.
- ... that all personnel has access to and also adheres to this operating manual when carrying out relevant tasks.
- ... that unauthorized personnel is not allowed to work with and on the lubrication system.

2.1.2 Qualified Personnel

Qualified personnel are persons who have been authorized by the safety officer of the plant to carry out the required tasks and who are able to recognize possible dangers and to avoid them due to their training, experience and the instructions they have been given as well as due to their knowledge of relevant standards, regulations, rules for prevention of accidents and working conditions.

2.2 General Safety Instructions

- We are not laying claim to completeness regarding these safety instructions. Please contact your local supplier if you have any queries or problems!
- All work stations and traffic routes must be kept clean and safe to access!
- Ensure that lighting is sufficient for safe operation!
- Ensure that the relevant regulations and guidelines are adhered to when installation or maintenance work is carried out in places where danger of falling exists!

- Ensure that the relevant safety and operating instructions are observed when the lubrication system is installed or serviced on machines or in factories (e.g. stop the machine)!

2.3 Safety Instructions for perma ECOSY 5

At the time of delivery the lubrication system is in line with state-of-the-art technology and is basically considered to be safe to operate.

WARNING



Dangers emanate from the lubrication system for persons, the lubrication system itself and for other material assets of the operator if:

... unqualified personnel operates the lubrication system!

... the lubrication system is used inappropriately and for operations that it was not intended to be used for!

... the lubrication system setting / variation is incorrect!

- Operate the lubrication system only when it is in perfect condition.
- Retrofitting, changing, or reconstructing the lubrication system is not allowed.
- If you are planning to modify the lubrication system, perma-tec must be consulted first.
- The lubrication system must be filled with the correct oil. It must be programmed so that it can operate perfectly and without danger for persons if it is correctly mounted, programmed, and appropriately used.

CAUTION



- **The safety instructions also apply to the operation with the complete equipment and its lubrication points!**
- **Ensure with appropriate measures that no material damage arises in the case of a failure with the lubrication system!**
- **Electrical cables must be faultless!**
- **Cables should not be misused!**

2.4 Safety When Handling Lubricants

WARNING



Lubricants may cause injuries to persons and may endanger your health! Consult a doctor immediately in case there is a risk of health damage!

- Avoid swallowing lubricant!
- Do not inhale lubricant vapors!
- Avoid any contact of lubricant with eyes, skin and clothing!
- Wear safety gloves and safety clothing!
- Lubricants on traffic ways will increase the danger of slipping. Therefore, the floor must be cleaned immediately with special cleaner!
- Observe safety data sheets of lubricants!
- Lubricants must be transported or stored in approved containers!
- Do not misuse lubricant containers and do not fill with other substances!
- Do not use damaged lubricant containers!
- Prevent lubricant from getting into soil or sewer system!
- For the disposal of lubricants, follow the individual waste disposal regulations in your country!
- Only use genuine spare-parts from perma-tec!

2.5 Safety in Case of Fire

- Personal protection comes before material protection!
- Warn other people and refuse access!
- Notify fire department (or ask someone else to do it)!
- Suitable extinguishers: fire extinguisher for flammable liquids and cooking oil, carbon dioxide extinguishers!
- Correctly dispose of irreparable lubrication systems
- see chapt. 14!

3 Technical Data

3.1 Product Characteristics

3.1.1 Design

perma ECOSY 5 basically consists of (fig. 3-1, 3-2):

- 1 Housing with mounting holes
- 2 Filling hole with filter and screw cap
- 3 Display and control unit
- 4 Cover of the pump compartment
- 5 Pump and distributor unit
- 6 Tube connections
- 7 Motor
- 8 Pump
- 9 Name plate (in pump area, on the left)



Fig. 3-1 perma ECOSY 5

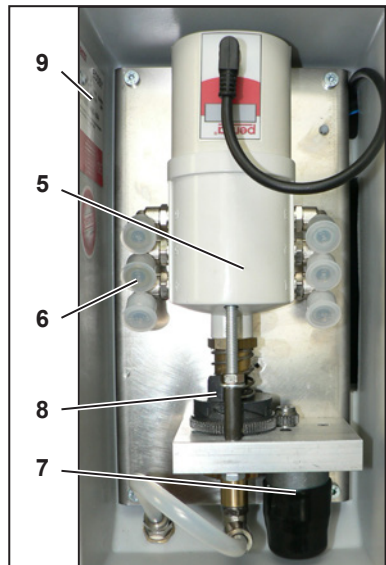

Fig. 3-2 Pump and distributor

3.1.2 Technical Data

CAUTION



Mechanical data	
Width, height, depth	310 × 380 × 170 [mm] (12.2 × 14.6 × 6.7 [in])
Weight empty	approx. 5 kg (11 lbs)
Tank volume	approx. 7 l (1.85 US gallons)
Pump capacity	0 to 9999 ml/1000 h (0 to 338.1 fl.oz/1000 h)
Max. pump capacity for all outlets combined	50 l (13.21 US gallons) per year
Pump discharge amount per lubrication impulse	max. 0.54 cm ³ from pump to distributor / see diagram in chapt. 9 discharge amounts
Permissible operation temperatures	-20 °C to +60 °C (-4 to +140 °F) with suitable oil
Noise emission	< 70 dB (A)
Viscosity range	65 to 2000 mm ² /s at 40 °C (104 °F)
Max. working pressure	10 bar (145 psi)
Max. tube length	≤ 10 m (33 ft) per lubrication point
Tube diameter	6 × 4 [mm] (0.24 x 0.16 [in])
Min. tube bending radius	50 mm (2 in)
Electrical data	
Power supply	24 V DC
	85 - 240 V AC / 50 - 60 Hz
Power consumption	approx. 25 W
Fill level sensor	internally
Thermo sensor	internally
Time control	•
Permanent signal	•
Sensor mode (ext.)	via external ECOSY Control sensor
Control sensor	external
Control sensor range	2 - 4 mm (0.08 - 0.16 in)
Cable length of control sensor	about 4.5 m (13.5 ft)
Signal interval	1 to 60 s
Languages (Display)	German, English (illuminated)

Note



All options exist; usable functions depend on connections and chosen accessories (see chapt. 10 Connection, 15.1 Accessories and 15.2 Spare Parts).

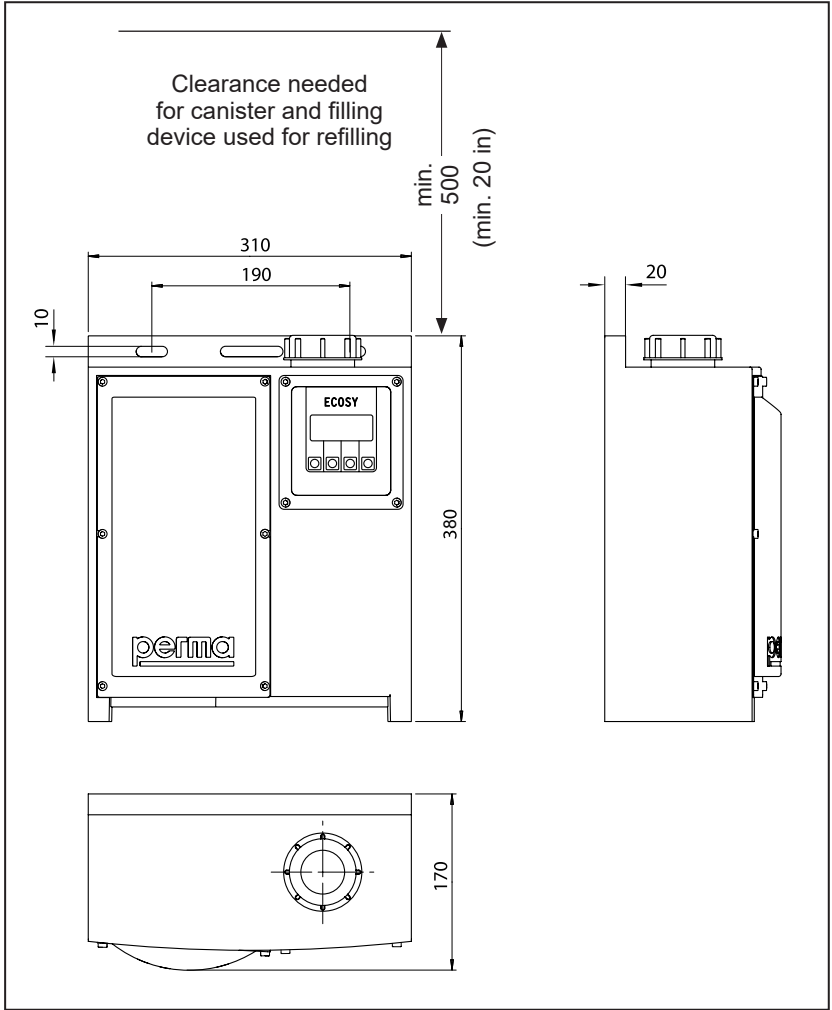

Fig. 3-3: External dimensions in mm

Note



If there is not enough space to refill the reservoir using a canister, use a pump (with filter) and a clean tube.

3.2 Operating Conditions

WARNING



The following restrictions must be observed for safe operation of the lubrication system and its connections:

- The lubrication system must not be placed, mounted and/or operated in an oxygen-enriched environment! - Explosion hazard!
- Oxygen cylinders or storage tanks with liquid or gaseous oxygen inside must not remain or be placed inside safety clearance zone (refer to corresponding safety data sheets)!
- DO NOT mount the lubrication system on surfaces where the temperature may exceed the permissible operating temperature of the lubrication system!
- DO NOT mount the system in places where hot gases or hot fluids may leak from pipes or tubes and may blow or flow against the lubrication system!
- Prior to any welding, the lubrication system must be removed from the area where temperatures may rise. Pipes or tubes containing lubricants must be removed from the danger area and, if necessary, they should be emptied!
- Prior to doing work where glowing metal parts or liquid metal drops may reach the lubrication system and/or its plastic tubes, protect any parts that could be reached and damaged by these heat sources!
- Prior to doing work where arcs might occur, protect any endangered tubes and ECOSY 5 parts!

3.2.1 Temperatures

- Range: -20 °C to +60 °C (-4 °F to +140 °F) with suitable oils.
- Within this temperature range and with a constant temperature, a precise discharge and a pressure build-up of up to 10 bar max. are guaranteed.

- If extreme temperatures exist (above +60 °C/+140 °F and below -20 °C/-4 °F), correct operation cannot be guaranteed. The system also has the option for the user to select and program a temperature limit. If the temperature falls below this selected limit, the system is shut down to prevent damage.

3.2.2 Ambient Conditions

- Ambient media, especially chemically aggressive substances, may damage sealing rings and plastic.

3.2.3 Lubricating Oils

- Oil for use in lubrication system perma ECOSY 5 cannot contain any solids. The viscosity class of the oil must be 65 to 2000 mm²/s at 40 °C. You may also download data sheets of lubricants supplied by perma-tec from perma-tec's web page (www.perma-tec.com) or ask your local supplier.

4 Storage

4.1 General Remarks on Storage

If perma ECOSY 5 is not immediately installed after receipt, ensure suitable storage of the lubrication system according to chapt. 4.1.1. Use original packing, if possible.

Storing a lubrication system (for a few weeks) that has already been in operation: We recommend that you dismount, empty, package and store the lubrication system (see chapt. 12)

4.1.1 Suitable Storage Conditions

- Enclosed, roofed buildings
- Dry
- Dust free
- Temperature +20 °C ±5 °C (+68 °F ±9 °F)

4.1.2 Storage Periods

- Filled ECOSY 5: Up to one year
- Empty ECOSY 5: More than one year

5 Mounting

5.1 Electrical Requirements

- Power supply with 24 V DC, 25 W; 8-pole plug (see chapt. 10.2) included, cable cross-section at least 0.75 mm (0.03 in)
- Power supply with 85 - 240 V AC / 50 - 60 Hz, 4-pole plug (see chapt. 10.1) included, cable cross-section at least 0.75 mm (0.03 in)

5.2 Required Tools (depending on mounting location)

- Tape measure
- Water level
- Flat wrench
- Allen wrench

5.3 Mounting the Lubrication System

CAUTION



Mounting material is not included!

Mounting material depends on the conditions on site and is not provided by perma-tec.

5.3.1 Mounting of Lubrication System and Tubes

We recommend that you fix the lubrication system with bolts M8 and DIN EN ISO 7090 washers or that you use a similar fixing method. Existing equipment can be used.

- Pay attention to the required clearance for the filling container and the filling device (Fig. 3-3).
- Bore the holes horizontally at a distance of 190 ± 5 mm (7.48 \pm 0.2 in) according to fig. 3-3 and fix the system with screws. Finger tighten screws and add a quarter turn.
- Remove cover of pump compartment (4, Fig. 3-1).
- Connect perma ECOSY 5 outlets with the lubrication point using tube or hose connections. Outlet number is imprinted on the distributor housing.
- Inactive outlets should be tightly sealed with a plug or blind plug.
- Connect tube lines tightly and securely with grease points (spray valve, brushes etc.).

- Run tube lines - observe min. bending radius of 50 mm (2 in). Secure lines.
- Shorten tubes with a tubing cutter. Make sure the cut is straight and clean (at right angle to center line of tube. Slanted, rough and chapped cuts will leak. For best results use tube cutter).
- Insert tube ends into lubricant outlets (6, fig. 3-2) and make sure they are tight and secure.
- Attach cover for pump area (4, fig. 3-1). Finger tighten allen screw.

5.3.2 Installing the ECOSY Control sensor

- Install control sensor. Ensure that connection cable is secure.
- Connect control sensor according to chapt. 10.2.3.
- Check: turn perma ECOSY 5 on and hold a piece of metal to the sensing end of the control sensor. If the control sensor was attached correctly, an indication light will light up on the back of the control sensor. The display will show an „S” for about 1 second.
- Adjust range (distance between control sensor end and piece of metal / 2 to 4 mm / 0.08 to 0.16 in). Hand tighten nut.
- If necessary, use the operating manual of the device or the system that is going to be lubricated by perma ECOSY 5.

5.4 Connection to Power Supply

- Connect ECOSY 5 with power supply **24 V DC** (see chapt. 10.2) or **85 - 240 V AC** (see chapt. 10.1).

Note



Electrostatic charging of the operator may cause a RESET if the operator touches any of the metal parts of the pump area. This is of no importance.

6 Operation

6.1 Preparation

Before starting perma ECOSY 5 for the first time, fill the reservoir until the display no longer shows „RESERVE“ (see chapt. 7).

Note



If there is not enough space to refill the reservoir using a container, use a pump (with filter) and a clean tube.

CAUTION



PRIOR to operating the lubrication system, all lubrication points and connection tubes/pipes must be sufficiently prefilled with the same lubricant that the perma ECOSY 5 contains!

In case of short connection tubes or pipes, the test function can be used for this purpose (see chapter 8.5 „Carrying Out a Test Run“). For longer tubes or pipes (longer than 2 m), an external pump is recommended (it takes about 12.6 cm³ of oil to fill 1 meter of tubing).

6.2 First Start and Operation

- perma ECOSY 5 comes with a standard factory set discharge of 0 ml / 1000 h (basic setting).
- Setting of the desired discharge can be done in increments of 1. Possible settings are 0 (outlet inactive) up to 9999 ml/1000 h.
- **Do not exceed the max. pump capacity of 50 l (13.21 US gallons) per year for all outlets combined.**

CAUTION



CAUTION



Before operation, users must determine and set the correct discharge for their application (see chapter 8.3.1 „Setting the Discharge Amount“)!

- Start the discharge by setting the desired operating mode (Configuration ⇒ Operating mode ⇒ Time controlled, permanent signal or sensor mode). (see chapter 8.4.2 „Setting of Operating Mode“). Depending on the selected operating mode (permanent signal or sensor mode), an external signal must exist.
- Use the test function (chapter 8.5.2 „Test Run for All Outlets“) to ensure that every activated outlet has been recognized by the system and will discharge according to the desired setting.

6.3 Check Prior to Operation

- Check the complete lubrication system for obvious damages!
- Was the system filled with the required and approved oil?
- Are all the parts correctly assembled and tightly screwed together?
- Are all connections and tubes / pipes correctly sealed?

Make corrections if necessary.

Fill up perma ECOSY 5 reservoir according to chapter 7.

6.4 During Operation

- Carry out regular visual inspections during operation. You should pay special attention to leakage and to the condition of the lubrication system and screw connections!
- Check fill level regularly.
Inspection: at regular intervals, depending on discharge settings.
Recommendation: once a month.
- perma ECOSY 5 can be linked to a superior control system (see chapter 10 „Connection of perma ECOSY 5“).
The fill level will then be monitored electronically and necessary refills will automatically be signalled via the PLC.
- In case of malfunctions, refer to trouble-shooting guide in chapter 11. If the problem cannot be fixed, contact your local supplier.

7 Refilling the Reservoir

7.1 General Points to Consider

The display indicates a necessary refill. The necessary refill is also transmitted to any linked superior control system.

CAUTION



- **No smoking, no open flames within a radius of 15 m (45 ft)!**
- **Use only oil that is recommended by perma-tec!
Ask your local supplier for a list of approved oils.**• **Ensure that no water or foreign liquids enter perma ECOSY 5 or the lubrication point. Refills may only be carried out in dry areas or with effective protective measures!**
- **If a different oil type is to be used, the user has to make sure, that the new oil is compatible with the oil formerly used in the lubrication system and that it is suitable for the application!**

7.2 Refilling Procedure

- Open the screw cap. Filter must remain in the filler neck. Check filter. If necessary, remove, clean, and re-insert filter.
- If necessary, use an approved, clean filling device (funnel) or pump (with filter) and a clean tube.

CAUTION



Make sure that the oil type in the refill container is correct!

- Refill oil of corresponding quality and type (max. fill level = bottom of filler neck).
- Screw cap on hand tight.
- If applicable, confirm minimum fill level error message (press button „OK” at the display).
- If necessary, check or change settings.

Discharge will continue.

8 perma ECOSY 5 Settings

CAUTION



Prior to operation, check setting of discharge volume and adjust it according to your particular application!

8.1 Control Panel Settings (Edit-Mode)

The following can be set at the control panel:

Parameters	Manufacturer setting
• Discharge volume per outlet	{PIN} (0 ml/1000h)
• Temperature limit for shut-off	{PIN} (-10 °C/+14 °F)
• Configuration	
• Operating mode	
– Time controlled	{PIN}
– Permanent signal	{PIN} (permanent signal)
– Sensor mode	{PIN}
• Temperature unit	
– Celsius	(°C)
– Fahrenheit	
• Language	
– German	(deutsch)
– English	
• Contrast	
– 00...14	{PIN} (00)
• New PIN	{PIN} (000)
• Test run	
• Single outlet	{PIN}
• All outlets (only configured outlets)	{PIN}

Note



Manufacturer settings listed above are used for series production. They may be different for customized, pre-configured systems.

Setting of perma ECOSY 5 is only possible in the Edit-Mode

All settings that are marked with „PIN” require the entry of the PIN (Personal Identification Number). The PIN is pre-set to „000” by the manufacturer. When you first start, you can change the settings by just confirming the pre-set PIN with „OK” in the PIN confirmation field.

However, we urgently recommend to select an individual PIN so that settings can only be changed by authorized staff.

8.1.1 Switch ON of ECOSY 5

As soon as power is supplied, perma ECOSY 5 will automatically start a self test. During the self test you can hear the distributor motor. No lubricant is supplied.

The display shows a row of dots at the bottom of the display.

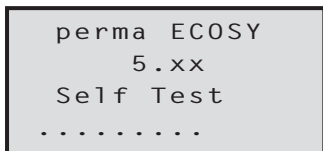

The two „xx” are only placeholders for future update numbers.

8.2 Function Indication

The status of the perma ECOSY 5 is shown on the display with „ON“ or „OFF“.

If „TIME CONTROL“ (Operating mode / Time controlled) was selected, the perma ECOSY 5 is always „ON“.

With „SENSOR MODE“ or „PERMANENT SIGNAL“, the lubrication system is only „ON“ if a signal is received from the machine that is to be lubricated (see chapter 10 „Connection of ECOSY 5“).

Pre-set factory values must manually be changed according to individual requirements.

Note



For printing reasons, the font used in the following display illustrations is not the same as in the actual display. Content and position, however, are identical.

8.2.1 Basic Screen Layout

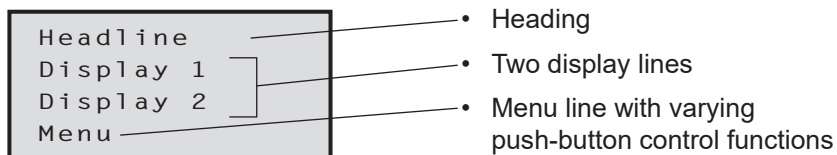

8.2.2 Main Menu

The main menu screen appears after the system has completed the self test.

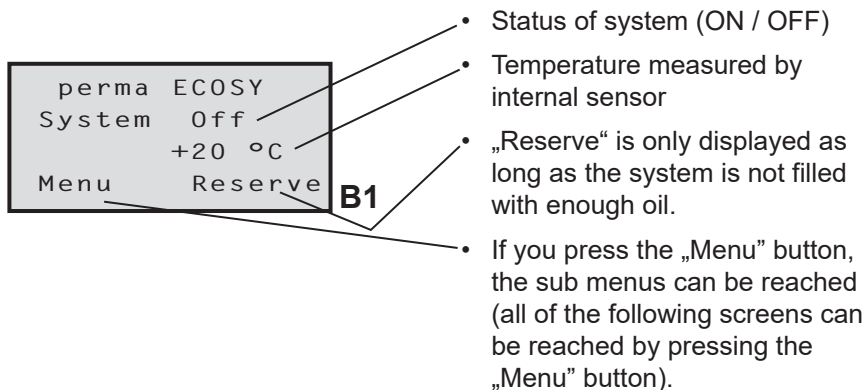

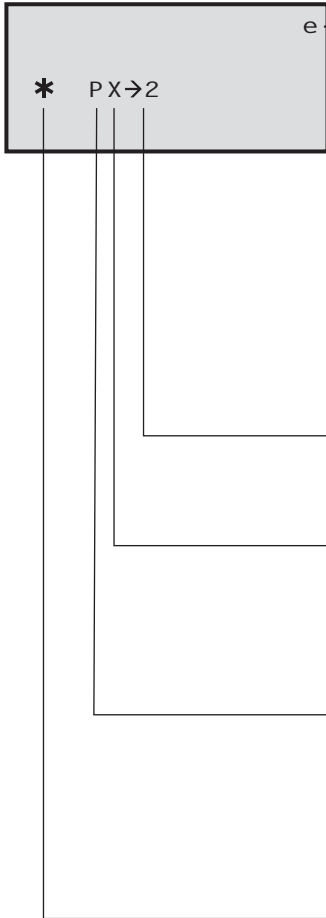

- „e” shows that you are currently in Edit-Mode. Edit-Mode is only possible after the PIN was entered.
 - If no button was pushed for more than 1 minute, display will return to main menu (B1) and the „e” will disappear.
 - During operation and during a test run, the active status will be indicated in the second or third line of the display:
 - “→2” Shows the outlet that is currently carrying out a discharge (in this example outlet 2)
 - “X” Discharge was triggered by external source (manually or from a superior control) [is linked to active sign: pump (P) or distributor (D)]
- P = pump active
D = distributor active
S = Control sensor impulse (is displayed for 1 second when the control sensor impulse arrives)
- “*” Temperature limit reached (system is OFF until temperature rises above the set limit again)

Note



If „X” and „*” shows in display, it indicates that an external discharge impulse was triggered while the system was shut down due to the temperature. This discharge impulse, and any additional ones, are saved in memory. Once the temperature rises again above the limit, the system will carry out all saved discharge impulses.

8.3 Setting of Parameters

8.3.1 Setting of Discharge Amount

Before you start operating the lubrication system, you must change the factory setting (0 ml/1000 h). Start and continue as follows:

```
perma ECOSY
System On
      +20 °C
Menu
```

B1

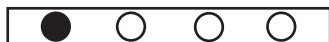

- [B1] Press „Menu“. ⇨ B2

```
Menu
→Parameter
Configuration
OK << >> Esc
```

B2

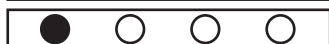

- [B2] Press „OK“. ⇨ B3

```
Parameter
→Vol. outlet 1
Vol. outlet 2
OK << >> Esc
```

B3

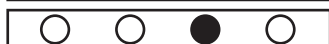

- [B3] Select the required outlet by pressing the arrow „>>“ button. ⇨ B4

```
Parameter
→Vol. outlet 2
Vol. outlet 3
OK << >> Esc
```

B4



- [B4] Press „>>“ again. Press „>>“ until the arrow on the screen appears next to the required outlet. ⇨ B5

```
Parameter
→Vol. outlet 3
Vol. outlet 4
OK << >> Esc
```

B5

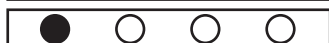

- [B5] In this example, the settings of outlet 3 will be changed. Press „OK“. ⇨ B6

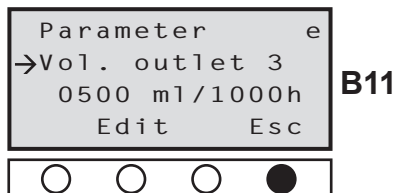
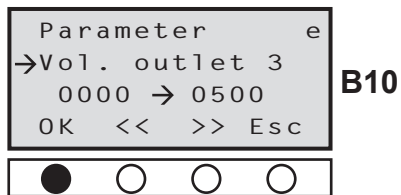
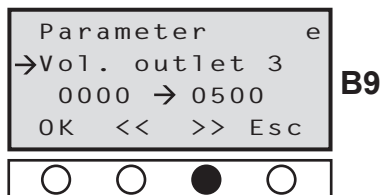
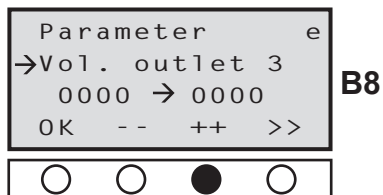
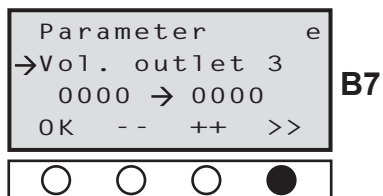
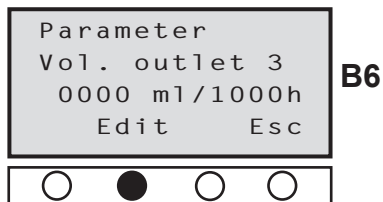

- [B6] The currently set discharge volume of the selected outlet is displayed.
To change, press „EDIT“ (after you have confirmed the selected PIN according to chapter 8.4.6).
⇒ B7
- [B7] The first digit of the value to be changed is underlined and blinking. With „++“ or „--“, you can change the value for this digit (no changes in this example) or go to the next digit with „>>“. ⇒ B8
- [B8] The selected digit is underlined and blinking (here, the second 0). With „++“ or „--“, you can set the required value for this digit (here, the value was increased to 5 for 500). ⇒ B9
- [B9] Go to the next digit with „>>“. Continue as described above until you have completed setting all desired values. ⇒ B10
- [B10] Save the displayed value with „OK“. ⇒ B11
- [B11] Exit this menu with „ESC“
- Every time you press „ESC“, you will reach a higher menu level.

- Tightly seal all inactive outlets with a plug (see menu „parameter“ outlets set to 0 discharge volume).

8.3.1.1 Checking the Discharge Volume of an Outlet

```
Parameter
→Vol. outlet 3
   0500 ml/1000h
   Edit      Esc
```

B11a

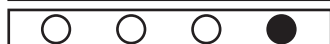

- If you want to check the discharge volume of a single outlet or of several outlets, proceed as described under 8.3.1 until B6 is shown. ⇒ B11a
- [B11a] Read the value
- Press „ESC“ as many times as necessary until you get to the main menu B1

8.3.2 Setting of Temperature Limit

perma ECOSY 5 is already shut down if the set temperature limit is reached. This means that if -5 °C (23 °F) was set, the discharging process will already be interrupted at -5 °C (23 °F) until the temperature rises above this set value again.

```
perma ECOSY
System On
      +20 °C
Menu
```

B1

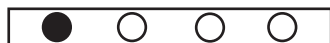

- [B1] Press „Menu“. ⇒ B2

```
Menu
→Parameter
Configuration
OK << >> Esc
```

B2



- [B2] Press „OK“. ⇒ B3

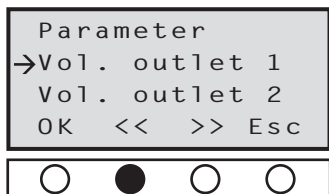

B3

- [B3] Select „Temperature“ by pressing the arrows „<<“ once. ⇒ B13

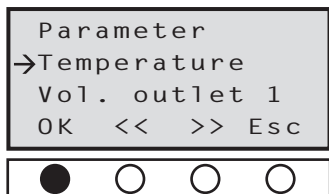

B13

- [B13] Press „OK“. ⇒ B14

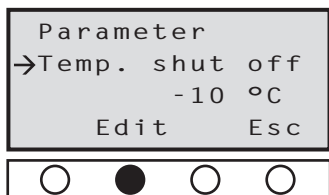

B14

- [B14] Display shows the currently set temperature at which the lubrication system is shut off. To change, press „EDIT“ (after selected PIN was confirmed according to chapter 8.4.5). ⇒ B15

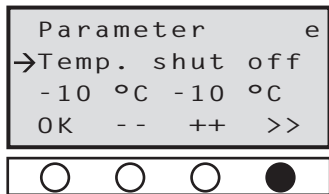

B15

- [B15] The temperature sign (+ or -) is underlined. Change to the desired sign with „++“ or „--“.

Press „>>“ to move cursor to the digit you want to change. ⇒ B16

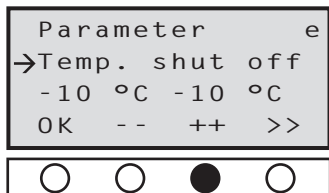

B16

- [B16] The desired digit is underlined. Increase the value by pressing „++“ or decrease the value by pressing „--“. ⇒ B17

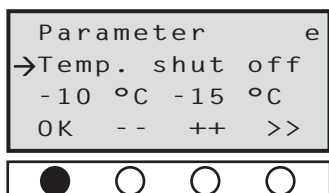

B17

- [B17] In this example we changed the value to -15 °C. Save the changed value with „OK“.
- Press „ESC“ as many times as necessary until you get to the main menu B1.

8.4 System Configuration

Note



- Discharges can be triggered by external control signals. Such signals do not come from the ECOSY 5 software, but from external sensors, a primary control, or a manual entry.
- Internal signals will convert the external signals into lubricant discharges.
External impulse signals can come from:
 - Mechanical or electrical switches
 - A primary control
 - A manual entry on the perma ECOSY

8.4.1 The Operating Modes - Selecting the Operating Mode

The perma ECOSY 5 has an internal time measurement function. This time measurement function is used to control and internally trigger oil discharges.

The perma ECOSY 5 can be operated in the following operating modes:

8.4.1.1 Discharge Process in Time Mode (Operating mode / Time controlled)

- In time mode, the ECOSY 5 runs autonomously (purely on a 24-hour basis) and calculates the discharge point based on the discharge volumes selected/set.
- The objective is to convey the selected volume to the lube point in equal amounts each time (programming basis is 1000 h).
- The discharges can be set independently of one another, i.e. operated with different volumes.

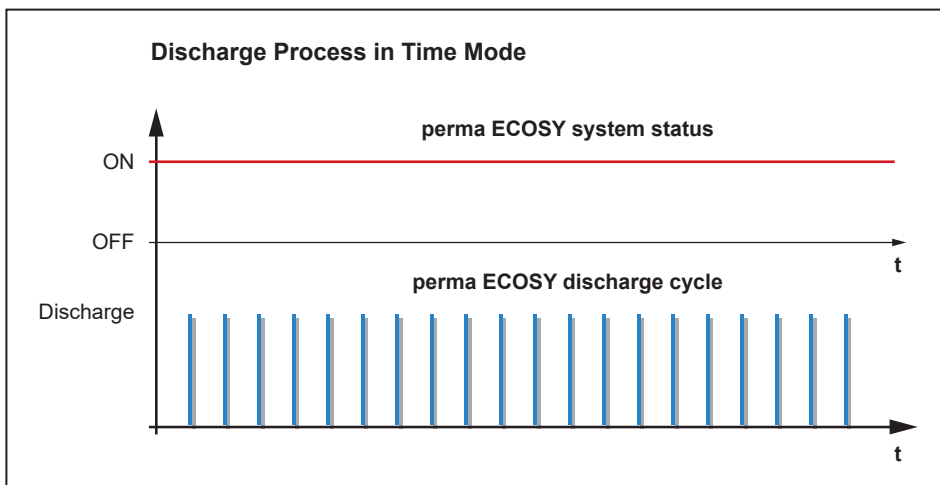

8.4.1.2 Discharge Process in Permanent Signal Mode

- In permanent signal mode, the ECOSY 5 reacts to the system status of the machine to be lubricated. Only the machine's „ON“ time is taken into consideration. Downtimes are not factored in for the discharge. To this end, the machine must send a signal (permanent signal, 24 V) to switch the ECOSY 5 „ON“ and „OFF.“
- The discharge point is calculated based on the discharge volumes selected/set, with only the machine's „ON“ times being taken into consideration.
- The objective is to convey the selected volume to the lube point in equal amounts each time (programming basis is 1000 h - although here this represents the number of hours worked by the machine).

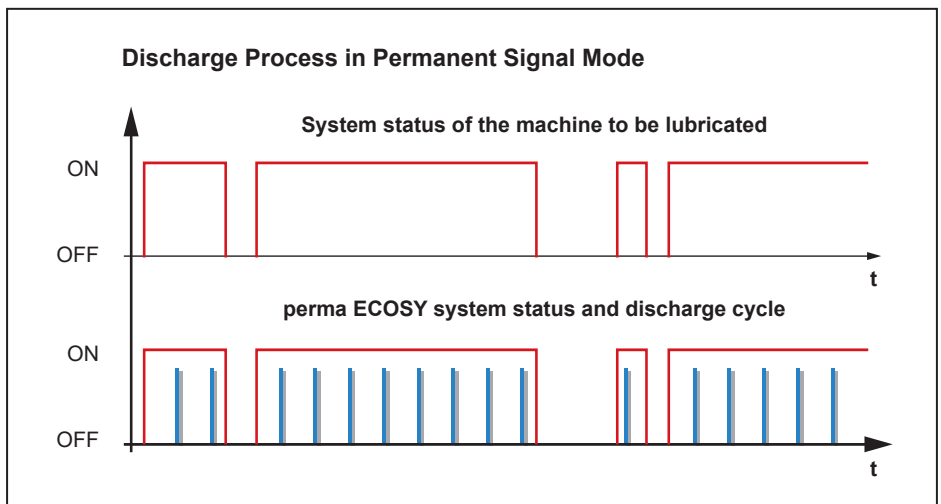

8.4.1.3 Discharge Process in Sensor Mode

- In sensor mode, the ECOSY 5 reacts to the system status of the machine to be lubricated. Only the machine's „ON“ time is taken into consideration. Downtimes are not factored in for the discharge. Control sensor signals (impulses, 24 V) are sent by the machine.
- The discharge point is calculated based on the discharge volumes selected/set, with only the machine's „ON“ times being taken into consideration.
- The objective is to convey the selected volume to the lube point in equal amounts each time (programming basis is 1000 h – although here this represents the number of hours worked by the machine).

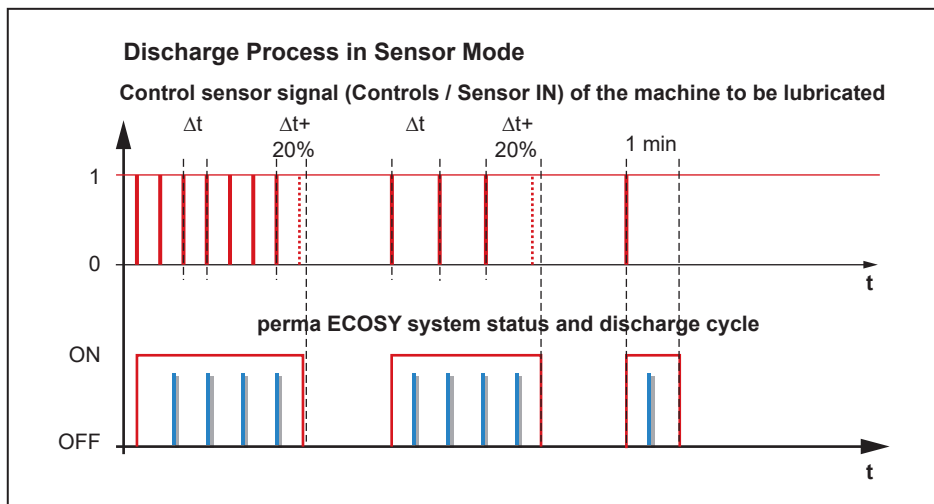

8.4.1.4 Additional Discharge

Additional discharges can be triggered by applying a control signal to input "Impulse IN" (Plug B, PIN 5).

These discharges are carried out independently of the selected operating mode.

When triggering an "additional discharge", all outlets are supplied with the same amount of lubricant.

The additional discharge can only be carried out when the lubrication system is turned on (display "ON").

8.4.2 Setting of Operating Mode

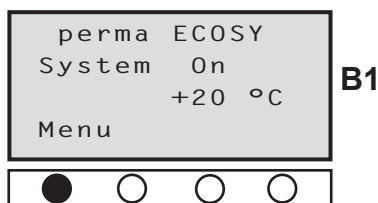

- [B1] Press „Menu“. ⇒ B18

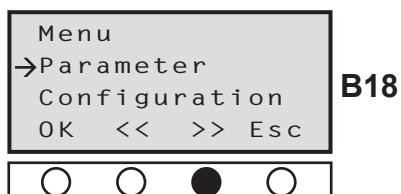

- [B18] Select „Configuration“ by pressing the arrows „>>“. ⇒ B18

Menu
→ Configuration
Test run
OK << >> Esc

B19

- [B19] Press „OK“. ⇒ B20

Configuration
→ Operating mode
Temp. unit
OK << >> Esc

B20

- [B20] „Operating mode“ is already selected. Press „OK“ (after selected PIN was confirmed according to chapter 8.4.6). ⇒ B21

Operating mode e
→ Time controlled
Perm. signal
OK << >> Esc

B21

- [B21] With the arrows „>>“, you can select “Time controlled” or ⇒ B22 “Perm. signal” or ⇒ B23 “Sensor mode”

Operating mode e
→ Perm. signal
Sensor mode
OK << >> Esc

B22

Operating mode e
→ Sensor mode
Time controlled
OK << >> Esc

B23

- [B23] Save the selected operating mode with „OK“. ⇒ B24 (or exit menu with „ESC“; changes are not saved).

Configuration e
→ Operating mode
Temp. unit
OK << >> Esc

B24

- [B24] After acknowledging with „OK“, press „ESC“ as many times as necessary until you get to the main menu.

8.4.3 Setting of Temperature Unit (°C or °F)

```
perma ECOSY
System On
      +20 °C
Menu
```

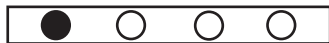
B1

```
Menu
→Parameter
Configuration
OK << >> Esc
```

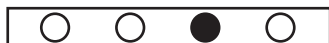
B18

```
Menu
→Configuration
Test run
OK << >> Esc
```

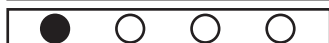
B19

```
Configuration
→Operating mode
Temp. unit
OK << >> Esc
```

B25

```
Configuration
→Temp. unit
Language
OK << >> Esc
```

B26

```
Temp. unit
→Celsius
Fahrenheit
OK << >> Esc
```

B27

- [B1] Press „Menu“. ⇒ B18
- [B18] Select „Configuration“ by pressing the arrows „>>“. ⇒ B19
- [B19] Press „OK“ to save the configuration. ⇒ B25
- [B25] Select „Temp. unit“ by pressing the arrows „>>“. ⇒ B26
- [B26] Press „OK“. ⇒ B27
- [B27] Select the required unit with the arrows „>>“ or „<<“. The display switches from Celsius to Fahrenheit and back again ⇒ B28

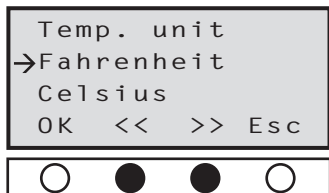

B28

- [B28] Fahrenheit is selected. The conversion is made based on the following formula:
... °F = ... °C × 9/5 + 32

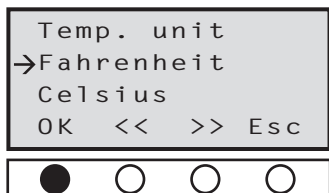

B29

- [B29] Save the setting with „OK“ or exit the menu item with „ESC“; changes are not saved.
- After saving the selected temperature unit, press „ESC“ as many times as necessary until you get to the main menu.

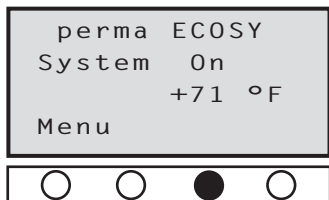

B1F

- [B1F] Example of the main menu screen after a change from °C to °F

Note



- The selected setting is directly saved with „OK“.
- The selected temperature unit is immediately shown as a whole number on the main menu.
- When the language is changed, the originally set temperature values remain. If required, they must be changed separately.
 - a) Temperature unit
 - b) Temperature shut-off

8.4.4 Setting of Language (pre-set to German)

```
perma ECOSY
Anlage Aus
      +20 °C
Menu
```

B1

- [B1] Press „Menu“. ⇒ B18

```
Menu
→Parameter
Konfiguration
OK << >> Esc
```

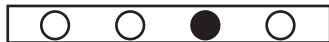
B18

- [B18] Select „Konfiguration“ by pressing the arrows „>>“. ⇒ B19

```
Menu
→Konfiguration
Testlauf
OK << >> Esc
```

B19

- [B19] Press „OK“. ⇒ B25
„Betriebsmode“ (= Operating mode)

```
Konfiguration
→Betriebsmode
Temp. Einheit
OK << >> Esc
```

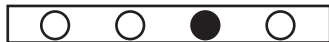
B25

- [B25] Select „Sprache“ (= language) by pressing the arrows „>>“ 2 times. If you press „>>“ only 1 time, display shows „Temp. Einheit“ (= Temp. unit) – see example in B26.

```
Konfiguration
→Temp. Einheit
Sprache
OK << >> Esc
```

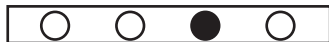
B26

- [B26] Press „>>“ again and display will show „Sprache“ (= Language) as shown in B30

```
Konfiguration
→Sprache
Betriebsmode
OK << >> Esc
```

B30

- [B30] Press „OK“. ⇒ B31



- [B31] Select the desired language with the arrows „<<“ or „>>“. The display switches from Deutsch (= German) to English and back again. ⇒ B32

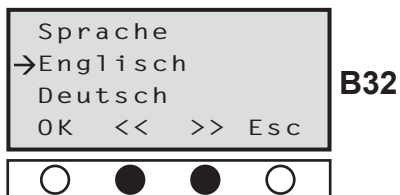

- [B32] In this example „English“ is selected. ⇒ B33

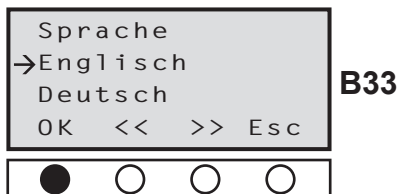

- [B33] Save the language selection with „OK“. The display immediately switches to the selected language and goes to the next higher menu. ⇒ B30E

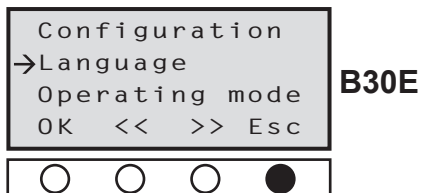

- [B30E] (Display in English) Press „ESC“ as many times as necessary until you get to the main menu B1. All menus are already in English

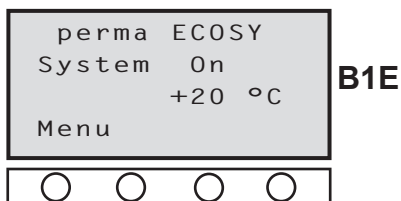

- [B1E] Display of the main menu in English

8.4.5 Adjusting the Contrast

```
perma ECOSY
System On
      +20 °C
Menu
```

B1

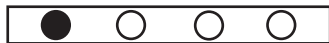

```
Menu
→Parameter
Configuration
OK << >> Esc
```

B18

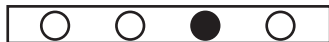

```
Menu
→Configuration
Test run
OK << >> Esc
```

B19



```
Configuration
→Operating mode
Temp. unit
OK << >> Esc
```

B25

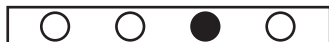

```
Configuration
→Temp. unit
Language
OK << >> Esc
```

B26



```
Configuration
→Language
Contrast
OK << >> Esc
```

B50

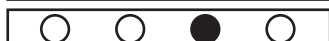

- [B1] Press „Menu“. ⇒ B18
- [B18] Select „Configuration“ by pressing the arrows „>>“. ⇒ B19
- [B19] Press „OK“. ⇒ B25
„Operating mode“
- [B25] Go to item „Contrast“ by pressing the arrows „>>“ three times.
(1st push of button:
Temp unit is displayed B26 /
2nd push of button:
Language is displayed B50 /
3rd push of button:
Contrast is displayed B51)

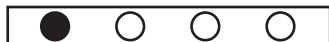

```
Configuration
→Contrast
Change PIN
OK << >> Esc
```

B51

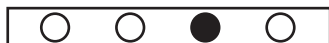

```
Contrast e
00
OK -- ++ Esc
```

B52



```
Contrast e
12
OK -- ++ Esc
```

B53



```
Contrast e
10
OK -- ++ Esc
```

B54



```
Configuration e
→Contrast
Change PIN
OK << >> Esc
```

B55



- [B51] Press „OK“ (After confirming PIN according to chapter 8.4.6).
⇒ B52

- [B52] The second digit is underlined and can be increased by pressing „++“. Increasing the number will decrease the contrast. ⇒ B53

- [B53] To increase the contrast, press „- -“ until you reach the desired contrast.

- [B54] Press „OK“ to save the selected contrast setting. ⇒ B55

- [B55] Press „ESC“ until you reach the main menu again.

8.4.6 PIN (Personal Identification Number)

ECOSY 5 settings can only be changed in the Edit-Mode. In order to get to the Edit-Mode, the correct PIN must be entered (for the initial start it is sufficient to confirm the factory set PIN „000” by pressing „OK”).

The screen for entering and **confirming** the PIN will automatically come up whenever there is a change of the technical settings.

The screen for **changing the PIN** can be found in the configuration menu. Contact your local supplier if you have forgotten your PIN!

8.4.6.1 Setting the PIN

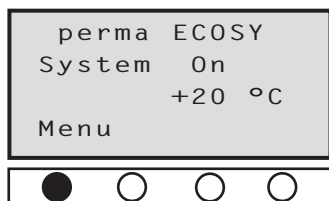

B1

- [B1] Press „Menu“. ⇒ B2

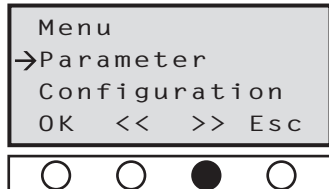

B2

- [B2] press „>>“. ⇒ B19

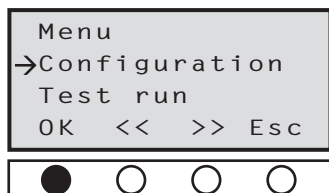

B19

- [B19] Press „OK“. ⇒ B25

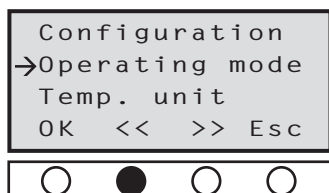

B25

- [B25] Press „<<“. ⇒ B44

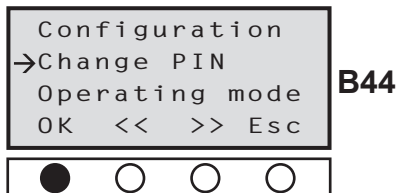

B44

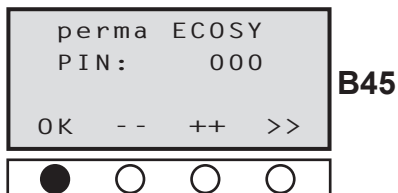

B45

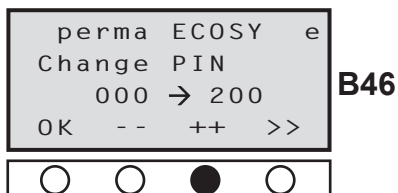

B46

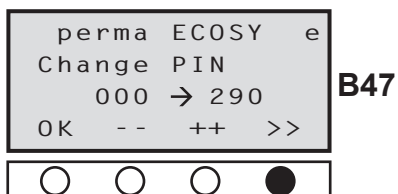

B47

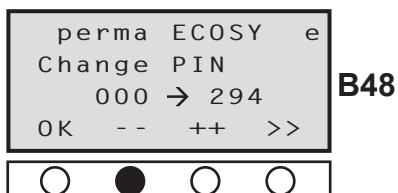

B48

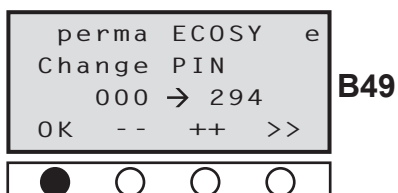

B49

- [B44] Press „OK“. ⇒ B45
- [B45] Confirm factory setting „000“ with „OK“. ⇒ B46
- [B46] Pressing „++“ increases the value of the active digit by one. Pressing „- -“ decreases the value by one. The active digit is always underlined. In this example, button „++“ was pressed 2 times, the display shows „200“. Pressing „>>“ activates the second digit of the PIN. Always select the desired digit by pressing „>>“.
- [B47] In this example, the second digit was changed from 0 to 9 by pressing „- -“ one time.
- [B48] Change the third digit the same way (in this example, the „4“ was selected). Confirm the new PIN with „OK“.
- [B49] The system saves the PIN and moves to the next higher level display.
- The starting display can be reached by pressing „ESC“ several times. The Edit-Mode stays active for about 1 minute after the last push of the button.
- If you want to re-activate the Edit-Mode, you must enter the correct PIN.

8.5 Carrying Out a Test Run

8.5.1 Test Run for a Single Outlet

```
perma ECOSY
System On
      +20 °C
Menu
```

B1

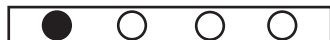

```
Menu
→Parameter
Configuration
OK << >> Esc
```

B18

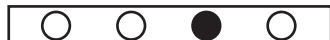

```
Menu
→Configuration
Test run
OK << >> Esc
```

B35



```
Menu
→Test run
Parameter
OK << >> Esc
```

B36



```
Testrun e
→Single outlet
All outlets
OK << >> Esc
```

B37



```
Single outlet e
→Outlet No. 1
OK -- ++ Esc
```

B38



- Only activated outlets will be supplied with grease during a test run.

• [B1] Press „Menu“. ⇒ B18

• [B18] Press „>>“. ⇒ B35

• [B35] Press „>>“. ⇒ B36

• [B36] Press „OK“ (after confirming PIN according to chapter 8.4.6). ⇒ B37

• [B37] Press „OK“ („Single outlet“ is already selected. Change is not necessary). ⇒ B38

• [B38] Select the required outlet with „++“ or „--“. ⇒ B39

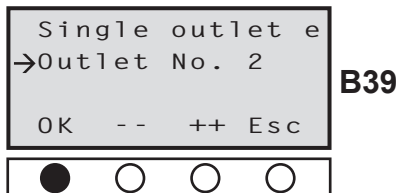

- [B39] Trigger a discharge with „OK“ (in this example for outlet 2) or exit menu with „ESC“ without triggering the discharge.
- If necessary, repeat test run.

Note



This step can also be carried out if you want to fill tubes up to a length of 2 m (6 ft).

- If necessary, carry out test runs for the other outlets as described
- [B40] Exit the menu with „ESC“ and press „ESC“ as many times as necessary until you get to the main menu B1.

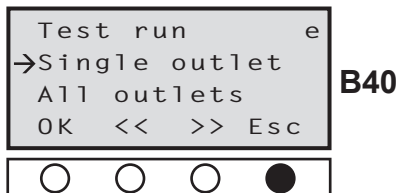

8.5.2 Test Run for All Outlets

Only activated outlets are supplied with grease (where the programmed discharge is greater than „0“ / see chapter 8.3.1 „Setting of Discharge Amount“).

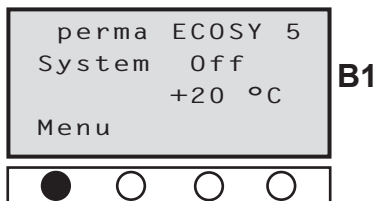

- [B1] Press „Menu“. ⇒ B18

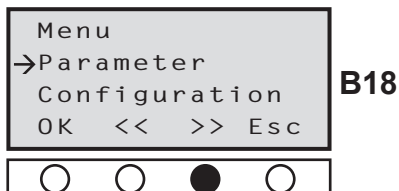

- [B18] Press „>>“. ⇒ B35

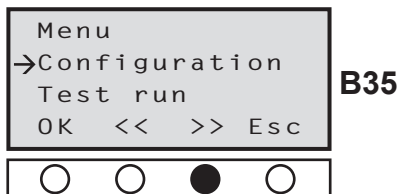

- [B35] Press „>>“. ⇒ B36

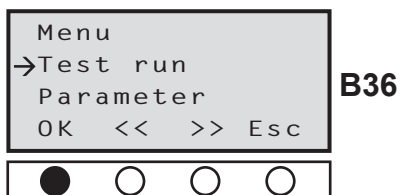

- [B36] Press „OK“ (after confirming PIN according to chapter 8.4.5). ⇒ B37

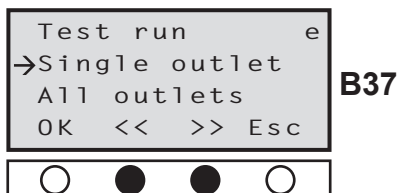

- [B37] Select „All outlets“ with „<<“ or „>>“. The display switches from „Single outlet“ to „All outlets“ and back again. ⇒ B41

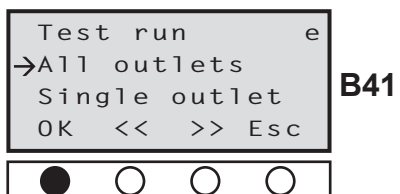

- [B41] Press „OK“. ⇒ B42
- [B42] The display indicates how many outlets were activated. Trigger a discharge to all outlets with „OK“ or exit menu with „ESC“ without triggering discharges. ⇒ B43.

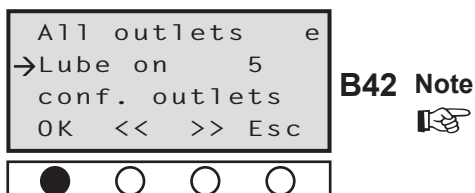

An error message will be displayed if an outlet has not been found (see „Error Displays“ in chapter 11).

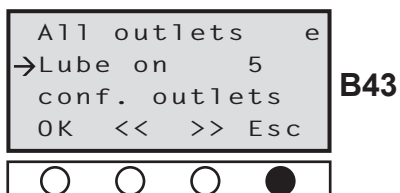

- [B43] After the discharge, exit menu with „ESC“. Press „ESC“ as many times as necessary until you get to the main menu.

9 Discharge Amount From Pump to Distributor Dependent on Counter Pressure and Temperature

Discharge amount from pump to distributor of ECOSY 5 will be constant, if the temperature is constant. In case of counter pressure from the lubrication point and if the temperature changes, the discharge volume may also change. Please refer to the diagrams.

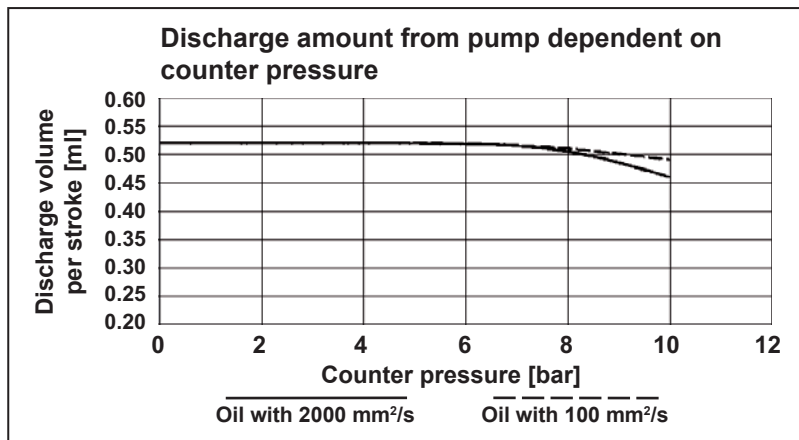

Fig. 9-1 Discharge amount from pump dependent on counter pressure

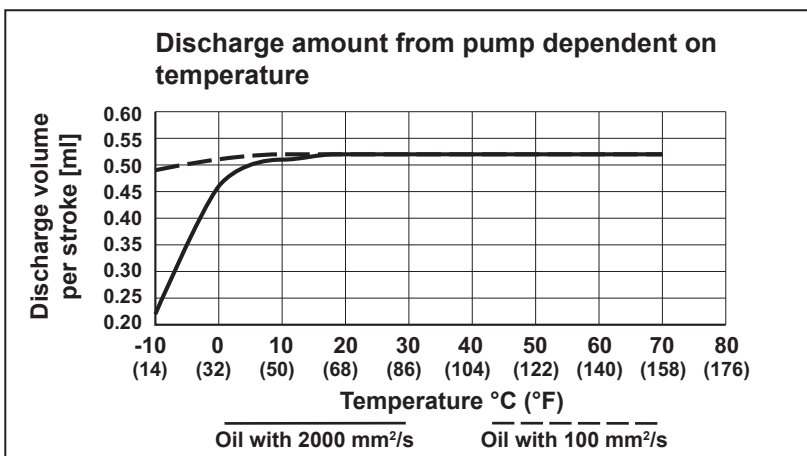

Fig. 9-2 Discharge amount from pump dependent on temperature

10 Connection of perma ECOSY 5

All tasks on the control system of the ECOSY 5 must be carried out by qualified staff.

Note



To ensure max. operating safety (e.g. broken wire), perma ECOSY 5 has been fitted with POSITIVE logic at the input side and with NEGATIVE logic at the output side.

WARNING



PRIOR to doing any work on ECOSY 5, all affected devices and the control system must be disconnected from power supply!

The perma ECOSY 5 is fitted with tip jacks, which are already connected internally to the power supply unit and the electronics.

10.1 The Mains Supply (85 - 240 V AC) - Connection Via Plug-in Connector A

The ECOSY 5 is connected to the power supply via the 4-pole plug-in connector. The plug is included with the delivery and can be connected as illustrated in the circuit diagrams.

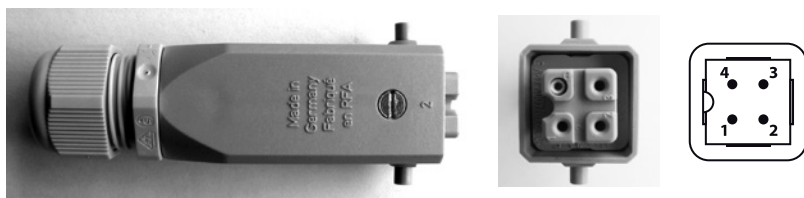

Fig. 10-1: Plug-in connector A (4-pole) for mains supply

Terminal marking	Plug A (Pin)	Abbreviation
External conductor (phase)	1	L1
Neutral conductor	2	N
NC / free	–	–
Grounding PE	–	–

10.2 The Control Panel - Connection Via Plug-in Connector B

The perma ECOSY 5 is connected to control systems via the 8-pole plug-in connector. The plug is included with the delivery and must be connected as illustrated in the circuit diagrams.

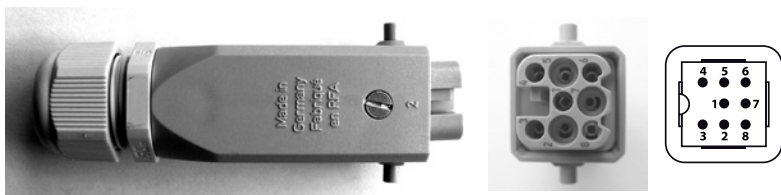

Fig. 10-2: Plug-in connector B (8-pole) for connection to control panel

Terminal marking	Plug B (pin)	PLC / Relays	Wire colour / No.
Controls / Sensor 24 V	1	24 V	white (1)
Fill level OUT	2	IN 2	brown (2)
Controls / Sensor GND	3	GND	green (3)
Controls / Sensor IN	4	OUT 1	yellow (4)
Impulse IN	5	OUT 2	grey (5)
Malfunction OUT	6	IN 1	pink (6)
Grounding GND	7	GND	blue (7)
24 V IN	8	24 V	red (8)

The outlets „Malfunction OUT“ and „Fill level OUT“ (K2/K3) can supply 0.1 A directly. This means that relays and signal lights can be activated directly.

10.2.1 Connection Via Relays

We recommend control via relays - see circuit diagram.

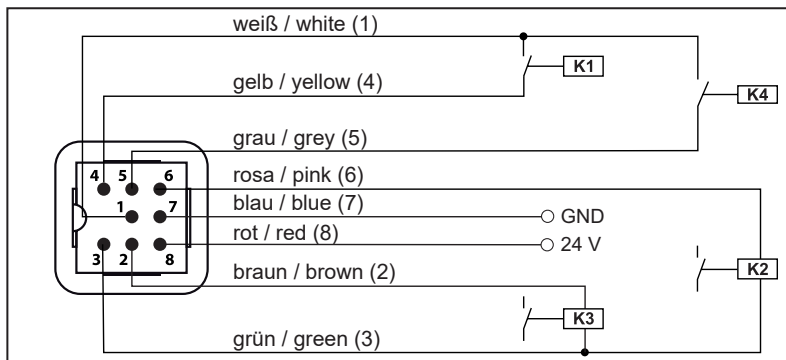

Fig. 10-3: Circuit diagram for connection via relays

K1: Control input from control cabinet via voltage free contact

K2: Error signal (active low)

K3: Filling level signal (active low)

K4: Input to impulse control from control cabinet via voltage-free contact (additional discharge)

10.2.2 Direct Connection to PLC

(Programmable Logic Controller)

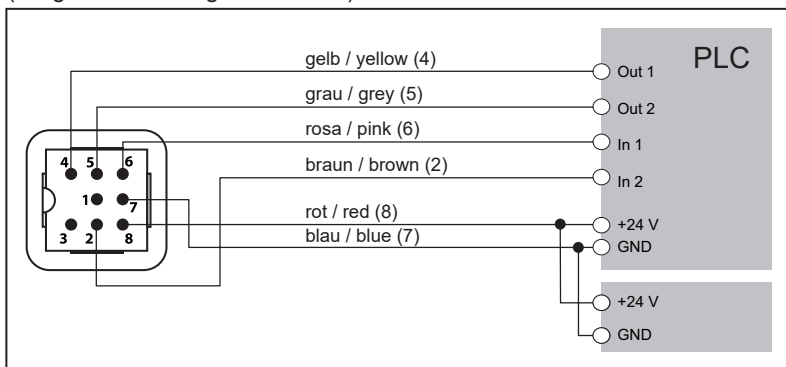

Fig. 10-4: Circuit diagram for direct connection to a PLC

CAUTION



- Connection to terminal „GND“ is imperative for direct connection to a PLC (Fig. 10-4)!
- For 24 V DC, the mains supply (plug connection A) **MUST NOT** be used!
- The used 24 V power supply must be sufficiently dimensioned for the operation of perma ECOSY acc. to its power consumption (chapter 3.1.2.).

10.2.3 Connection of ECOSY Control sensor

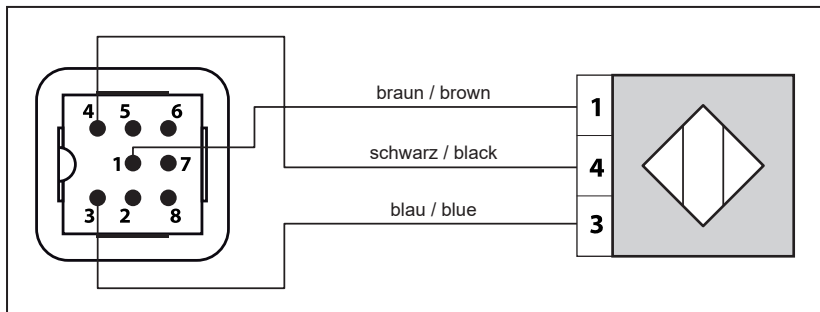

Fig. 10-5: Circuit diagram for connecting the ECOSY Control sensor

Terminal marking	Plug B (pin)	Control sensor
Controls / sensor 24 V	1	1 brown
Controls / sensor GND	3	3 blue
Controls / sensor IN	4	4 black



Fig. 10-6: ECOSY Control sensor with cable

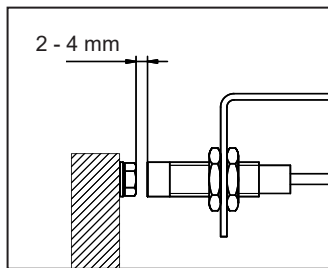

Fig. 10-7: Range

11 Troubleshooting

If you encounter any malfunctions while operating the lubrication system, please check for possible causes using the following trouble shooting guide. If you have to deal with an error that is not listed please contact your local supplier.

Error displays

The errors listed are displayed on screen as follows:

	perma ECOSY Error reserve min. level OK	perma ECOSY Error outlet X blocked OK
1	2	3
perma ECOSY Error pump not working OK	perma ECOSY Error internal communication OK	perma ECOSY Error no. X disch. overflow OK
4	5	6
perma ECOSY Error distrib. drive OK	perma ECOSY Error distrib. position OK	perma ECOSY Error distrib. initialization OK
7	8	9

Note



Error messages are acknowledged and reset by pushing the OK button.

Error	Possible causes	Suggested solution
1 No display; ECOSY 5 does not respond and is not working	Dead socket / connection. Selected Operating mode and applied signals do not correspond.	- Check power supply and ensure that power is supplied - Check input signals of superior control - Check the set Operating mode
2 ECOSY 5 displays: „Error reserve min. level“	Filling level of perma ECOSY 5 has fallen below the minimum.	- Refill oil (at least until the reserve display is no longer indicated), then acknowledge error.

Error	Possible causes	Suggested solution
3 ECOSY 5 displays: „Error outlet X blocked“	Outlet X blocked. If less than six outlets are used, the wrong outlet could be sealed or connected.	- Check tube and lubrication point for bends and blockages. - Check menu for activated outlets and check which outlets were mechanically sealed with a plug (mech. sealed outlets can not be activated).
4 ECOSY 5 displays: „Error pump not working“	Stroke recognition of pump defective, or defective pump.	- Send perma ECOSY 5 to your local supplier for repairs.
5 ECOSY 5 displays: „Error internal communication“	I ² C communication on the electronic unit causes error.	- Send perma ECOSY 5 to your local supplier for repairs.
6 ECOSY 5 displays: „Error No. X disch. overflow“	There are more than 10 discharges for a single outlet lined up. More than 10 test runs have been entered or the outlet is blocked and has been switched off.	- Acknowledge the error. Check if the outlet is blocked. - Do not enter more than 10 test runs in a row.
7 ECOSY 5 displays: „Error distrib. drive“	The current was permanently too high / too low during operation. Distributor with mechanical defect. Distributor not connected.	- Counter-pressure of the system is too high. Check if outlets are blocked. - Send perma ECOSY 5 to your local supplier for repairs.
8 ECOSY 5 displays: „Error distrib. position“	Distribution position sensor not found.	- Send perma ECOSY 5 to your local supplier for repairs.
9 ECOSY 5 displays „Error distrib. initialization“	Distributor initialization sensor not found. Number of outlets does not correspond to the initialization value.	- Disconnect perma ECOSY 5 from power supply and reconnect it after 30 sec. perma ECOSY 5 carries out initialization. If the same error occurs again, send the ECOSY 5 to your local supplier for repairs.

12 Dismounting the Lubrication System

12.1 Preparation for Dismounting

WARNING



Follow these instructions **BEFORE** you dismount ECOSY 5:

- **Disconnect ECOSY 5 from power supply!**
- **Observe safety instructions! - Chapter 2.**
- **Observe safety instructions for handling lubricants!**
- chapt. 2.4 page 11.

Dismounting the lubrication system:

- Tubes might be under pressure. To catch leaking oil, place oil sump under ECOSY 5. Get assistance if necessary.
- Remove tubes from tube connections (6, figure 3-2). First, push the release of the tube connection (using a suitable tool) and then pull out the tube.
- When removing tube connections from lubrication points, use an oil sump to catch any leaking oil (proceed the same way for any connections, extensions, T-connections, couplings and fittings).
- Empty the tubes and pour oil into appropriate containers.
- Tightly seal containers and secure them against unintentional spilling.
- Seal tube ends with plugs or blind plugs.
- Tightly seal tube connections on the ECOSY 5 with plugs or blind plugs.
- Absorb any spilled oil and completely remove it from the floor.

If ECOSY Control sensor is installed:

- Disconnect the plug-in connector of the control sensor or PLC from the ECOSY 5.

12.2 Dismounting the ECOSY 5

CAUTION



Position the ECOSY 5 upright at a safe place so that no oil may spill and the system is protected against damages and overturning (recommendation: place the lubrication system in a leak proof container like a tub)!

- Dismount ECOSY 5 from application (see chapt. 5 for mounting steps and use reversed order for dismounting).
- Remove any loose parts and clean workplace.

13 Shipping

13.1 Preparation and Dispatch

- Use original packing.
- Dismount the system according to chapt. 12 and empty it completely.
- Tightly seal openings with plugs or blind plugs.

CAUTION



Make sure that the packing material is not damaged and that no oil can leak!

- Wrap ECOSY 5 with oil-tight foil and seal it with tape.
- Place ECOSY 5 in its original packing and secure it against bumps and mechanical influences using packing material.
- If ECOSY 5 is sent to your local supplier, enclose shipping documents and technical notes (or a description of the problem).
- You may download a RETURN FORM from our website www.perma-tec.com
- Hand over the parcel to a delivery agent for forwarding to local supplier.

14 Disposal

Help us in protecting the environment and saving resources by recycling valuable raw material.

Please follow the individual waste disposal regulations in your country.

15 Accessories for perma ECOSY 5

Accessories and spare parts must meet the technical requirements!

This is always guaranteed with genuine spare parts from perma-tec.

We recommend that you contact local suppliers if you are planning to extend your system or to install accessories or spare parts on perma lubrication systems.

15.1 Accessories

- perma brushes and special brushes
- Mounting angles and oil throttles
- Other accessories upon request

15.2 Spare Parts

The following spare parts are available and can be ordered from your local supplier:

- | | |
|-------------------------|--------------------------------------|
| • Housing | • Electronic unit |
| • Pump distributor unit | • Power supply unit |
| • Tube connections* | • Fill level sensor |
| • Plug 4-pole, 8-pole | • ECOSY Control sensor
with cable |

CAUTION







- * **Every time you remove and re-install tube connections to the distributor, secure the screw connection with Loctite 243 or a similar screw locking sealant!**

16 Maintenance and Service

Maintenance of perma ECOSY 5 mainly consists of visual checks, re-fills, and re-setting. The filter of the filler neck should be cleaned if it contains any dirt.

Send ECOSY 5 to your local supplier for any other maintenance work.

For shipment of perma ECOSY 5 to your local supplier, please refer to chapt. 12 and 13 for correct dismounting and shipping.

				
EG/EU-Konformitäts- erklärung nach Richtlinie 2006/42/EG (u. Richtlinie 2014/30/UE)	EC/EU Declaration of Conformity according to Directive 2006/42/EC (and Directive 2014/30/UE)	Déclaration CE/UE de conformité selon la directive 2006/42/CE (et directive 2014/30/UE)	Declaración CE/UE de conformidad según la directiva 2006/42/CE (y directiva 2014/30/UE)	Dichiarazione di conformi- tà CE/UE secondo la direttiva 2006/42/CE (e direttiva 2014/30/UE)
perma-tec GmbH & Co. KG Hammelburger Straße 21 97717 EUERDORF / GERMANY				
Der Hersteller erklärt hiermit, dass das bezeichnete Produkt in den gelieferten Ausführungen den Bestimmungen der oben gekennzeichneten Richtlinien - einschließlich derer zum Zeitpunkt der Erklärung geltenden Änderungen - entspricht.	The manufacturer hereby declares that the product as described in the given statement conforms to the regulations appertaining to the directives referred to above, including any amendments thereto which are in force at the time of the declaration.	Le fabricant déclare par la présente que le produit désigné dans sa version livrée est conforme aux dispositions des directives citées ci-dessus - ainsi qu'aux modifications en vigueur au moment de la certification.	Por la presente el fabricante declara, que todas las versiones disponibles de este producto se ajustan a las directivas arriba indicadas, incluyendo los cambios que se produzcan al tiempo de emitir esta declaración.	Il produttore con la presente dichiara che il prodotto designato nei modelli consegnati è conforme alle disposizioni delle norme sopra riportate, incluse le variazioni valide al momento della dichiarazione.
In der Gemeinschaft ansässige Person, die bevollmächtigt ist, die relevanten technischen Unterlagen zusammenzustellen:	Person residing within the Community authorised to compile the relevant technical documentation:	Personne établie dans la Communauté autorisée à établir le dossier technique pertinent:	Persona con residencia en la Comunidad que está autorizada a crear los pertinentes documentos técnicos:	Persona residente nella Comunità autorizzata a raccogliere la documentazione tecnica necessaria:
(siehe Hersteller-anschrift)	(see manufacturer address)	Egon Eisenbacher (cf. l'adresse de fabricant)	(ver dirección del productor)	(vedere indirizzo del fabbricante)
Produktbezeichnung:	Product description:	Désignation:	Tipo de producto:	Descrizione del prodotto:
Automatisches Schmiersystem	Automatic lubrication system	Système de lubrification automatique	Sistema de lubricación automático	Sistema di lubrificazione automatica
Produktname:	Product name:	Nom du produit:	Denominación producto:	Nome del prodotto:
ECOSY				
Typ:	Type:	Type:	Tipo:	Tipo:
5				
Folgende harmonisierte Normen wurden angewandt:	The following harmonised standards were applied:	Les normes associées suivantes ont été utilisées:	Se han aplicado las siguientes normas de armonización:	Sono state recepite le seguenti norme di standardizzazione:
EN ISO 12100:2010 (EN 61000-6-2:2005, EN 61000-6-4:2007+A1:2011)				

Euerdorf, 20 October 2015



Walter Graf, Managing Director



Egon Eisenbacher, Technical Management

perma-tec GmbH & Co. KG
Hammelburger Str. 21
97717 EUERDORF
GERMANY

Tel.: +49 9704 609-0
info@perma-tec.com
www.perma-tec.com